

## REMOTE NODE PART NUMBER: ENGND04101

The Remote Node provides 10 outputs for connection to vehicle devices (up to 50 Amps max - see operating temperature limits).

- (4) 10-amp solid state switchable outputs
- (6) 5-amp solid state switchable outputs.

The Remote Node also provides 4 inputs to control systems.

- Active High/Low selectable.

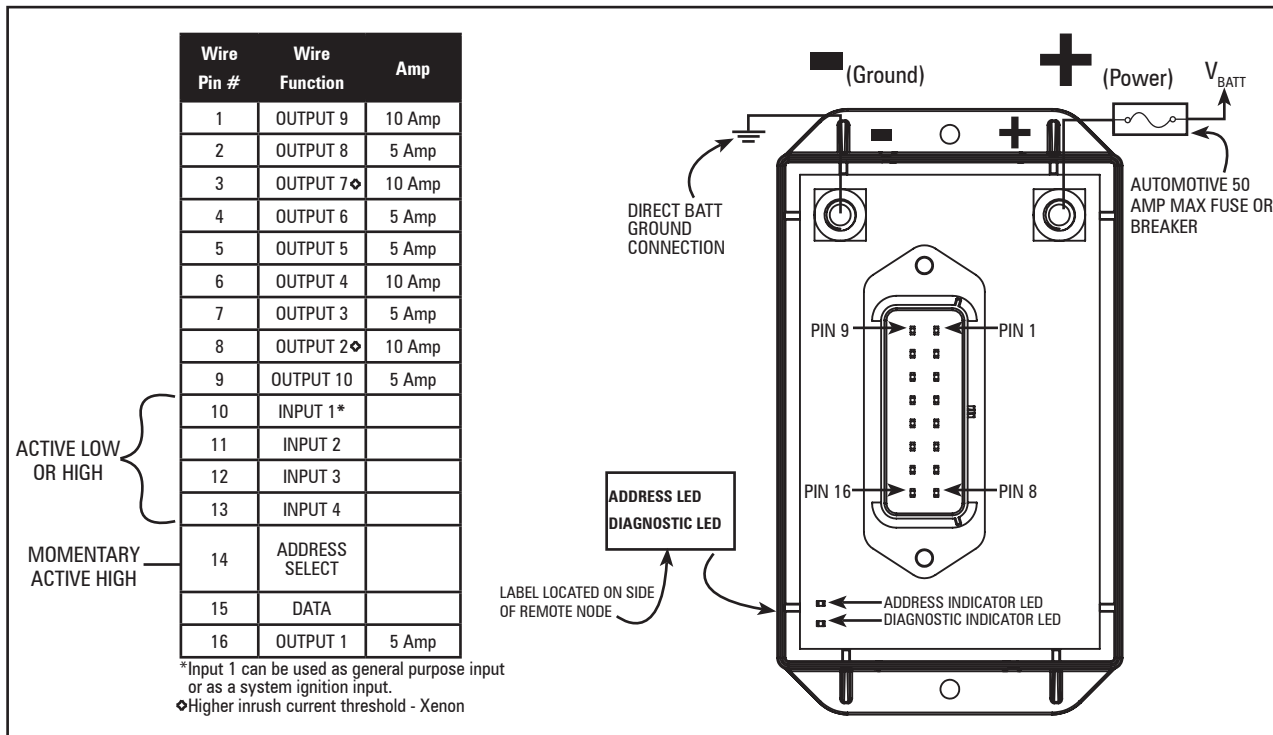
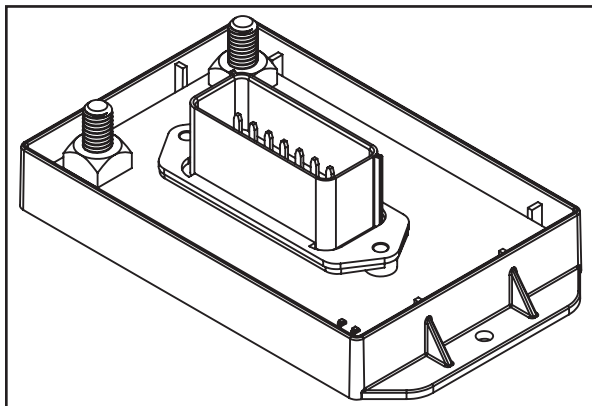

### ⚠ WARNING

- HIGH CURRENT interconnects must be properly terminated. Poor crimp quality can cause heat build-up and fire. Follow crimp connector manufacturer instructions.
- DO NOT install this product or route any wires in the Air Bag Deployment Zone. Refer to vehicle Owner's Manual for deployment zones.
- Do NOT use system to disconnect headlights, brake lights or other safety equipment.
- Unit may become hot to touch during normal operation.
- Failure to properly install connectors, fuses or wiring may cause vehicle failure or fire.
- Installation must only be performed by trained technician. Installer must determine vehicle wiring configuration and proper integration of system.
- Use proper wire gauge and fuse for the application/current draw. All power wires connecting to positive (+) or negative (-) battery terminal or local chassis ground (-) must be sized to supply at least 125% of max. current and properly fused at power source. Install protective grommets when routing wire through firewall or metal.



1.800.338.7337 / www.soundoffsignal.com

See attached Install Template to aid in connections and programming

Please see next page for Technical Specifications

### NOTICE:

Installers and users must comply with all applicable federal, state and local laws regarding use and installation of warning devices.

*Improper use or installation may void warranty coverage.*

To review our Limited Warranty Statement & Return Policy for this or any SoundOff Signal product, visit our website at [www.soundoffsignal.com/tech-services/returns/](http://www.soundoffsignal.com/tech-services/returns/).

If you have questions regarding this product, contact **Technical Services**, Monday - Friday, 8 a.m. to 5 p.m. ET at 1.800.338.7337 (press #4).

Questions or comments that do not require immediate attention may be emailed to [techservices@soundoffsignal.com](mailto:techservices@soundoffsignal.com).



## ⚠ WARNING

- Not Reverse Polarity Protected. Verify Power and Ground connections before energizing.
- Install fuse or breaker (size for 50Amps max.) on main power supply.
- Install included mounting plate between Remote Node and the vehicle to maintain flatness.
- Do NOT connect product to strobe power supply. Product is self-contained; no external power supply needed.
- Follow attached Wiring and Interconnect requirements.
- Torque the provided M8 nuts with lock washer to a maximum of 7ft-lbs. on power terminals.
- Verify that the lockwasher is fully seated when assembled.
- Verify wire outside diameter is sized properly to work with seals on 16pin connector (see pg. 3).

### SETTING NODE ADDRESS

To set the node addresses:

1. Default address is 1.
2. Momentarily connect power to PIN 14.
3. Address indicator LED will wink the address (1-5).
4. Repeat until the correct address is selected.
5. After address 1 is set it will cycle through the addresses until it gets back to 1.

### DIAGNOSTIC LED

- The diagnostic LED is steady on when the device is powered up and running with no errors.
- The diagnostic LED is off when the device is off or in sleep mode.
- The diagnostic LED winks when there is a system fault or the device is in firmware upgrade mode.
  - Fault condition is read by counting the number of times the LED “winks” on. Each fault condition will generate a pattern where each “wink” is 250ms off/250ms on. The pattern is terminated by the LED being off for 2.5 seconds.
  - The LED will wink multiple patterns when more than one fault condition is active.

### FAULT CONDITION PATTERNS:

- 1 Wink - RPDU output(s) are latched off due to over-current faults. Reset the Central Controller to restore operation.
- 2 Winks - Communication fault
- 3 Winks - Source voltage level is < 9 VDC
- 4 Winks - Source voltage level is > 16 VDC
- 5 Winks - Over temperature condition



1.800.338.7337 / www.soundoffsignal.com

Tech Specs	bluePRINT® Control System Remote Node
<b>Input Voltage:</b>	10-16Vdc (Negative Ground)
<b>Maximum Total Current &amp; Operating Temp:</b>	50 Amps (-40° to 65°C), 30Amps (-40° to 85°C), 15Amps (-40° to 105°C)**
<b>Outputs (Sum of ALL used Outputs Shall Not Exceed 50Amps)</b>	4x 10Amp Solid State, Switched 6x 5Amp Solid State, Switched
<b>IGN ON: Standby Current:</b>	60mA
<b>IGN OFF: Sleep Current:</b>	0.34mA
<b>Inputs:</b>	4x Total 3x Active High/Low Inputs *1x Active high/Low Input w/ System Wake up
<b>Reverse Polarity Protection:</b>	Not Protected (Reverse Polarity will Destroy the Devices)
<b>Transient Protection:</b>	Protected
<b>High Voltage Protection:</b>	> 16V; High Voltage Error Code Set
<b>Low Voltage Protection:</b>	< 9V; Low Voltage Error Code Set
<b>Dimensions:</b>	6.0" x 3.4" x .8"
<b>Weight, Boxed:</b>	13.2 oz.
<b>Weight, Device Only:</b>	10.7 oz.
<b>Valid Input Threshold High:</b>	> 8.0V
<b>Valid Input Threshold Low:</b>	< 1.5V
Hermetically sealed providing protection in wet areas.	

\*Input 1 can be used to sense ignition status for overall system operation

Multi-color lights should be driven by outputs within the same output group (Group 1: 1-5, Group 2: 6-10) to align timing.

By default even outputs flash alternating with odd outputs when enabled in software.

\*\*Applies to high temperature rated product with black potting encapsulation. Under-hood mounting is application specific and should be verified not to exceed maximum temperature limits in the vehicle usage conditions. Maintain at least 24" from high heat sources such as engine and radiator.

### NOTICE:

Installers and users must comply with all applicable federal, state and local laws regarding use and installation of warning devices.

*Improper use or installation may void warranty coverage.*

To review our Limited Warranty Statement & Return Policy for this or any SoundOff Signal product, visit our website at [www.soundoffsignal.com/tech-services/returns/](http://www.soundoffsignal.com/tech-services/returns/).

If you have questions regarding this product, contact **Technical Services**, Monday - Friday, 8 a.m. to 5 p.m. ET at 1.800.338.7337 (press #4).

Questions or comments that do not require immediate attention may be emailed to [techservices@soundoffsignal.com](mailto:techservices@soundoffsignal.com).







ENHANCING SAFETY THROUGH INNOVATION

## ⚠️ WARNING

• High current interconnects require careful termination with the proper equipment. **WARNING! Poor crimp quality can cause significant heat build-up and fire.** Follow connector manufacturer instructions to terminate properly.

• Remote Node can switch up to a **total maximum of 50Amps**. User must configure outputs to not exceed this total current. Individual output switches are rated up to 10Amps each for higher current loads, **but the total device current must not exceed 50Amps**. The software warns when these limits are exceeded and user must ensure that individual output limits and total device current limits are not exceeded in normal use.

• **Do not gang or parallel multiple outputs to drive a high current load.** Multiple 5Amp and 10Amp outputs must not be combined to achieve a higher current limit.

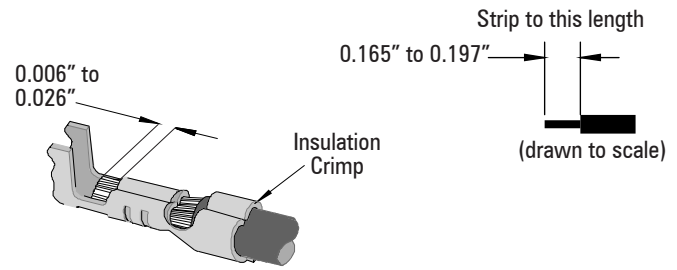
TERMINATION OPTION 1		TERMINATION OPTION 2		
Purchase accessory mating harness from SoundOff Signal		Purchase individual connector components to terminate the wires at the connector.		
<b>SoundOff P/N:</b> ENGHNK02 (16pin Mating Harness – 18 inches) ENGHNK04 (16pin Mating Harness – 15 foot) ENGHNK03 (10 foot Harness Kit for Remote Node)		<b>Molex P/N:</b> 19418-0030	<b>Molex P/N:</b> 19420-0001	<b>Molex P/N:</b> 19417-0119
				
	• Typically, a water tight butt-splice with glue is used to protect this termination and is required for exterior use.	MX150L™ 16 Circuit Sealed Receptacle for 14-16 AWG Wire 	MX150L™ Female Terminal for 14-16 AWG Wire, Tin Plated	MX150L™ Socket Plug/Key (One plug required for each unused pin location to seal)
Pros:	<ul style="list-style-type: none"> <li>• No need to terminate at the connector pins</li> <li>• no need to purchase Molex crimper</li> </ul>	<ul style="list-style-type: none"> <li>• MX150L Assembly Instructions: <a href="http://www.molex.com/pdm_docs/as/AS-19417-001.pdf">http://www.molex.com/pdm_docs/as/AS-19417-001.pdf</a></li> <li>• Application Tooling Specification Sheet: <a href="http://www.molex.com/pdm_docs/ats/ATS-6381144HM.pdf">http://www.molex.com/pdm_docs/ats/ATS-6381144HM.pdf</a></li> <li>• Quality Crimping Handbook: <a href="http://www.molex.com/pdm_docs/ats/TM-638000029.pdf">http://www.molex.com/pdm_docs/ats/TM-638000029.pdf</a></li> <li>• Actual terminal and housings may be different depending on application, wire type, etc.</li> </ul>		
Cons:	<ul style="list-style-type: none"> <li>• Requires butt-splice or alternate connector</li> <li>• Requires heat shrink tubing with glue for exterior</li> </ul>	<ul style="list-style-type: none"> <li>• Hand Crimp Tool: <b>Molex P/N:</b> 63811-4400</li> <li>• Manual Extraction Tool: <b>Molex P/N:</b> 63813-1500</li> </ul>		
		<ul style="list-style-type: none"> <li>• <b>WARNING! Wire diameter with insulation must be 0.113in to 0.139in (2.87mm-3.53mm) to properly seal (such as SXL 16AWG)</b></li> </ul>		
		Pros:	• Consistent wire colors, clean install without butt-splices	
		Cons:	• Need to purchase crimper and train personnel	

### NOTICE:

Installers and users must comply with all applicable federal, state and local laws regarding use and installation of warning devices.

*Improper use or installation may void warranty coverage.*

To review our Limited Warranty Statement & Return Policy for this or any SoundOff Signal product, visit our website at [www.soundoffsignal.com/tech-services/returns/](http://www.soundoffsignal.com/tech-services/returns/).

If you have questions regarding this product, contact **Technical Services**, Monday - Friday, 8 a.m. to 5 p.m. ET at 1.800.338.7337 (press #4).

Questions or comments that do not require immediate attention may be emailed to [techservices@soundoffsignal.com](mailto:techservices@soundoffsignal.com).

Department: \_\_\_\_\_

Vehicle: \_\_\_\_\_

Installer / Date: \_\_\_\_\_

Mounting Location: \_\_\_\_\_



Wire Color

Function

Function

Wire Color

_____	_____	5A, Output 10, Pin 9	Pin 1, Output 9, 10A	_____	_____
_____	_____	Input 1, Pin 10	Pin 2, Output 8, 5A	_____	_____
_____	_____	Input 2, Pin 11	Pin 3, Output 7, 10A	_____	_____
_____	_____	Input 3, Pin 12	Pin 4, Output 6, 5A	_____	_____
_____	_____	Input 4, Pin 13	Pin 5, Output 5, 5A	_____	_____
_____	ID # _____	Module Select, Pin 14	Pin 6, Output 4, 10A	_____	_____
_____	_____	DATA, Pin 15	Pin 7, Output 3, 5A	_____	_____
_____	_____	5A, Output 1, Pin 16	Pin 8, Output 2, 10A	_____	_____

◇ = Xenon inrush