

## INSTALLATION INSTRUCTIONS FOR SPEAKER BRACKET (ETSS100CBKDC) (2006 THROUGH 2010 DODGE CHARGER)

### SAFETY MESSAGE TO OPERATORS AND INSTALLERS OF SOUNDOFF SIGNAL SIREN/SPEAKER SYSTEMS.

#### Signaling Limitations:

Sirens/speakers provide an essential function of an effective audio-visual warning system. However, sirens are only short range secondary devices. The use of a siren/speaker system does not insure that all drivers can or will abide by or react to an emergency warning signal, especially at high rates of speeds or long distances. The operator of the vehicle must never take the right of way for granted and it is the operator's responsibility to proceed safely.

The effectiveness of the siren/speaker system is highly dependant on the correct mounting and wiring. The installer must read and follow manufacturer's installation instructions and warnings in the manual. The vehicle operator should verify the siren/speaker system is securely fastened to the vehicle and properly functioning.

Maximum sound output will be severely reduced if any objects are in front of the speaker. If your installation has obstructions in front of the speaker, drive even more cautiously.

#### Sound Hazards:

Effective siren/speaker systems generate loud sound pressure levels (120db) that can potentially cause permanent hearing damage. Installers and those around the vehicle need to be aware of the dangers and wear hearing protection whenever the siren system is operating.

Vehicle operators and occupants should asses their exposure to siren noise and determine what steps need to be taken to prevent hearing damage. For hearing conservations guidance, refer to federal, state, or local recommendations. OSHA Standard 1910.95 offers guidance on "Permissible Noise Exposure".

#### Qualifications:

To properly install a siren, you must have a good understanding of automotive systems, electronics and procedures.

The siren/speaker system is intended for use by authorized personnel only. The user's responsibility to ensure they understand and operate the emergency warning devices in compliance with all applicable city, state, and federal laws and regulations and have a thorough knowledge of state and federal UNIFORM TRAFFIC CODES.

SoundOff Signal assumes no liability for any loss resulting in the use of this warning device.

#### During Installation:

Do not get metal shavings inside of speaker. Metal shavings can cause speaker to fail. If metal removing must be done near the speaker, place a cover over the unit to prevent metal shavings from getting inside of speaker.

Do not route speaker wires where they may interfere with the operations or deployment of the air bag or it's sensors. Equipment mounted near the air bag deployment area will damage or reduce the effectiveness of the air bag. The user/installer assumes full responsibility to determine proper mounting location, based on providing safety for passengers inside the vehicle.

#### After Installation:

Test the siren and light system to ensure that everything is operating properly.

Test all vehicle functions to ensure that installation has not affected vehicle operation or changed vehicle safety function.

Store these instructions in a safe place and refer to them when performing maintenance and/or reinstallation of product.

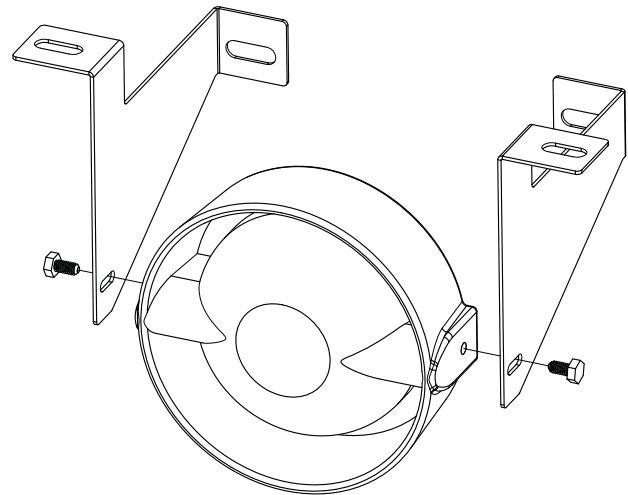

#### Charger Installation Kit Includes:

- 1 - Left Side Bracket
- 1 - Right Side Bracket

#### Tools Needed For Installation:

- Socket driver set
- Flat head screw driver

#### Other Parts Needed For Installation:

- SoundOff Signal Speaker 100C and 2 hex head screws provided with speaker.

### **WARNING**

Sirens produce loud sounds that may damage hearing:

- Roll up windows
- Wear hearing protection
- Use only for emergency response
- Avoid exposure to siren sound outside of vehicle



# ETSS100CBKDC CHARGER SPEAKER BRACKET INSTALLATION:

1. Open hood, locate and remove 2 plastic shields that are between radiator cross bar and grille. See figure 1.

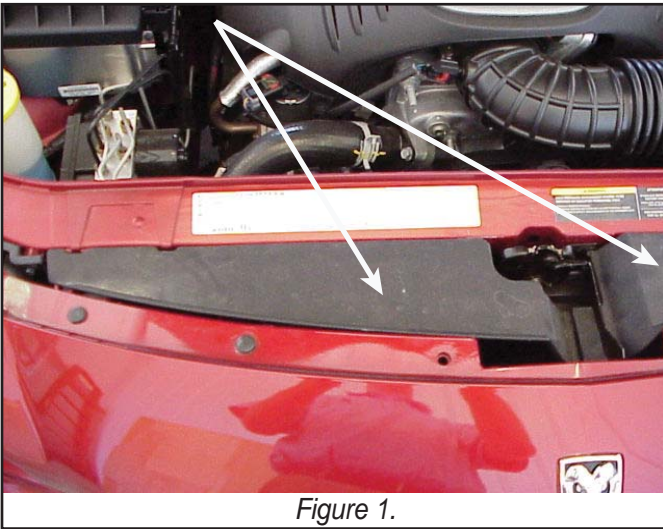

Figure 1.

2. Remove and retain pop-up tabs on both sides.

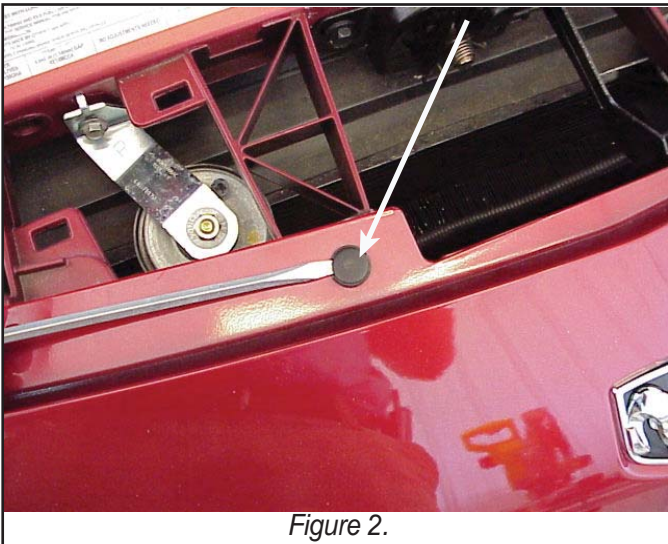

Figure 2.

3. Remove and retain both bolts that secure hood latch. Move hood latch out of the way where it will not interfere with speaker bracket installation. See figure 3.

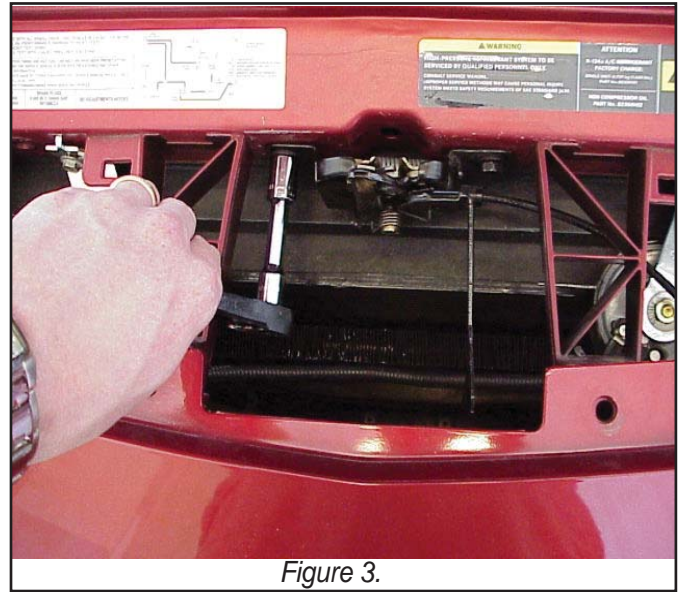

Figure 3.

4. Remove passenger and drivers side horn using wrench or ratchet. Both horns are removed with one bolt each. See figure 4. Horn removal will make installation and speaker and bracket installation easier to access.

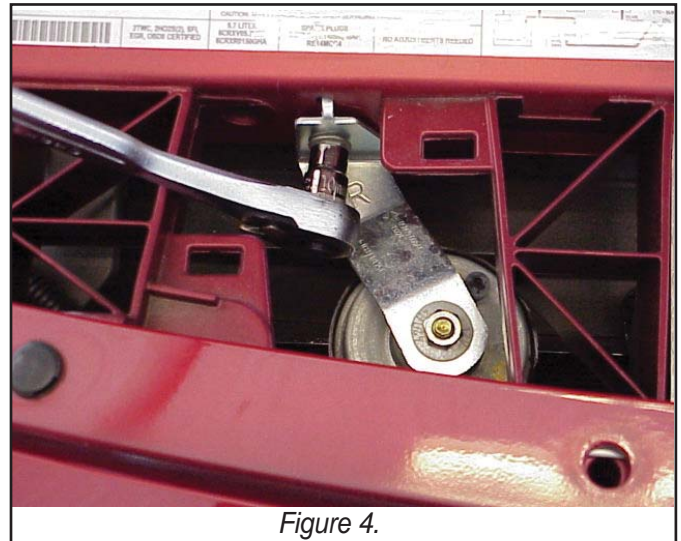

Figure 4.

## **⚠ WARNING**

Sirens produce loud sounds that may damage hearing:

- Roll up windows
- Wear hearing protection
- Use only for emergency response
- Avoid exposure to siren sound outside of vehicle



5. Place brackets into open space in the middle between grille and radiator cross bar as shown in figure 4. Top side of brackets will sit underneath front fascia and on top of support beams. After brackets are in place, re-install pop up tabs that were removed in step 4. Note placement in figure 5 of hood latch.

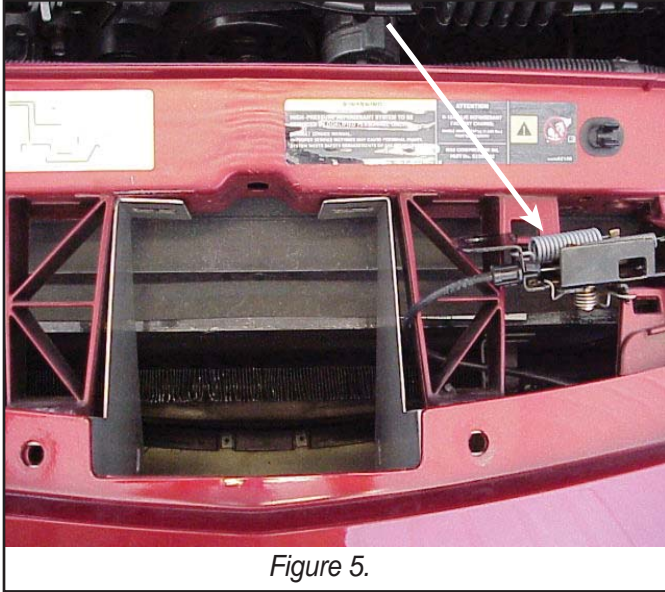

Figure 5.

6. Lower speaker into place. Be sure that wire exits the bottom of speaker. Wire exit also functions as weep hole. Hand tighten screws into speaker by reaching through where horn was located and was removed in step 4.

7. Reinstall hood latch removed in step 3. Hood latch should be between brackets and radiator cross bar. Hood latch cable must run underneath brackets.



Figure 6.

8. After latch and bracket are secured by replacing bolts, Place speaker at desired angle and tighten screws on both sides. (Ratchet with extension works best.)

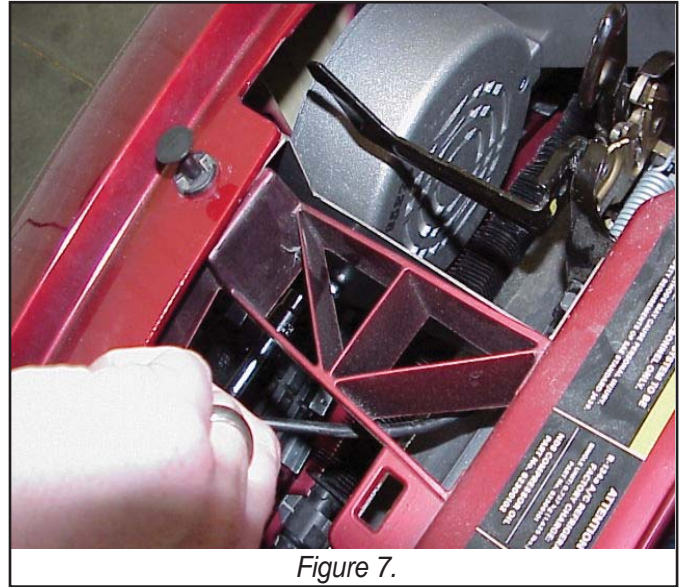

Figure 7.

8. Connect the wires from the speaker to the electronic siren's speaker cable. Refer to the siren instructions for details. Before replacing horns or covers, be sure to test the unit to ensure that it is functioning properly.

9. Replace driver and passenger side horns that were removed in step 4.

10. Replace plastic covers removed in step 1.

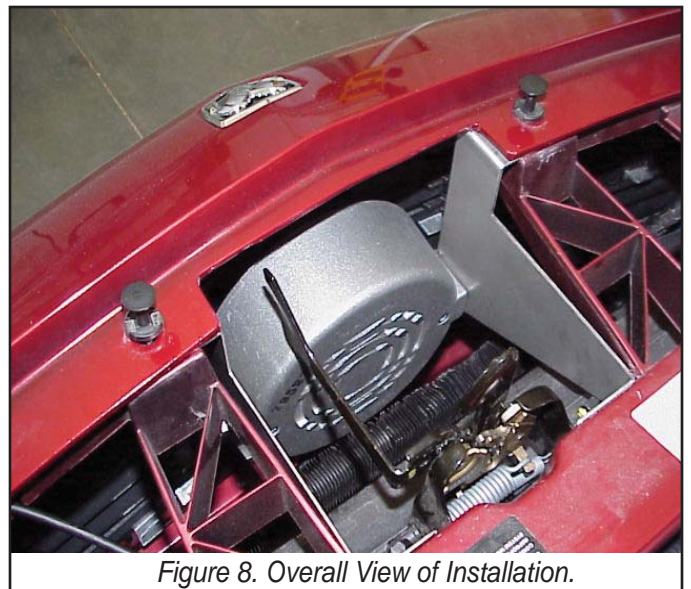

Figure 8. Overall View of Installation.

11. Close hood and check hood and body alignment. Adjust latch assembly if required for proper hood alignment.

**To review our Limited Warranty Statement & Return Policy for this or any SoundOff Signal product please visit our website at [www.soundoffsignal.com](http://www.soundoffsignal.com) and select the "Warranty & Returns" link along the left column of our home page. If you have questions regarding this product please contact Technical Services, Monday - Friday, 8 am to 5 pm at 1.800.338.7337, press #4 to skip the automated message. Questions or comments that do not require immediate attention may be emailed to [techsupport@soundoffsignal.com](mailto:techsupport@soundoffsignal.com).  
1.800.338.7337 / [www.soundoffsignal.com](http://www.soundoffsignal.com) / Thank you for trusting us with your safety!**